

Article number: 20956507

Description: E+GLEvelling foot
GN 342.2-50-M12-100-SV

Measures

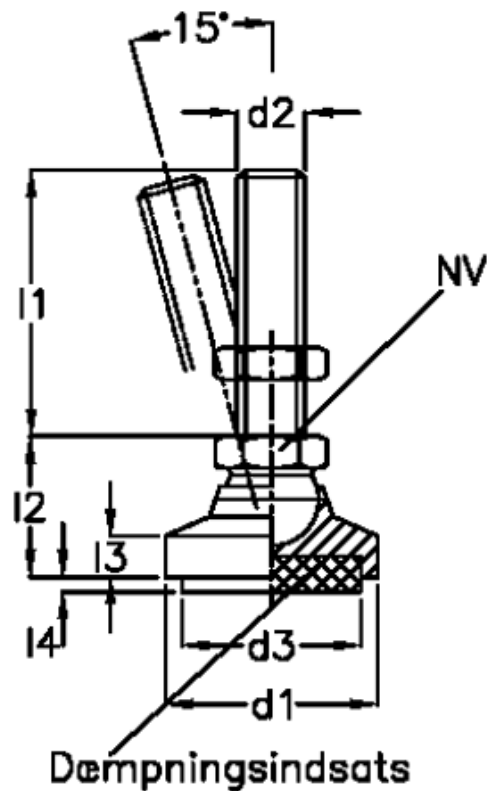

Area(m ²) damping insert = 1809	l ₄ compression 0.4 N/mm ²	= 5.3
d ₁ = 50	l ₄ compression 0.6 N/mm ²	= 4.4
d ₂ = M12	Load (N) by compression 0.4 N/mm ²	= 720
d ₃ = 48	NV	= 18
l ₁ = 63	t	= 11.5
l ₂ = 30.5		
l ₃ = 9.0		
l ₄ compression 0 N/mm ² = 6.5		